



SMART LIGHTS FOR LIFE

 **DENKIRS**

2024/1

About company.....	2
Track system SMART.....	4
SMART GRILL.....	8
SMART LINEAR.....	10
SMART SPOT.....	12
SMART MOON.....	14
SMART RAY.....	16
SMART CONTROL.....	18
SMART BASE.....	20
SMART HIDE.....	22
SMART ONE.....	23
Track belt system BELTY.....	24
BELTY SPOT.....	28
BELTY GRILL.....	30
BELTY LINEAR.....	31
BELTY FLOW.....	32
BELTY ORB.....	34
BELTY BASE.....	36
Ultra-slim track system AIR.....	38
AIR GRILL.....	42
AIR LINEAR.....	43
AIR SPOT.....	44
AIR REFLEX.....	45
AIR HANG.....	46
AIR RAY.....	47
AIR BASE.....	48
Slim LED.....	50
Spotlights.....	52
RODVIG.....	56
VIBI.....	58
Waterproof spotlights.....	60
PORT.....	60
DEEP.....	61
Symbols and Indicators.....	62
Technical characteristics.....	64



ABOUT DENKIRS

DENKIRS is a brand specializing in advanced technological track lighting systems.

Our products feature LED modules from the world's leading manufacturers, including OSRAM, CREE, and BRIDGELUX. We utilize aluminum with high-quality textured painting for the bodies of our luminaires, along with a heat-resistant polymer for our plastic product series. This polymer, also used in motorcycle parts manufacturing, can withstand temperatures up to 120 degrees Celsius. Tested under extreme stress conditions, this unique material ensures the reliability and durability of our lights. All our products are certified for quality and come with a 3-year warranty.

DENKIRS represents excellence in modern lighting equipment and a team of professionals dedicated to providing support to clients at every stage of cooperation. We offer consultations on projects and assist in selecting the right equipment.

DISCOVER DENKIRS PRODUCT CATEGORIES

- track system SMART
- ultra-slim magnetic track system AIR
- belt track system BELTY
- recessed spotlights
- waterproof recessed spotlights
- surface-mounted spotlights
- ultra-slim LED modules SLIM LED



ADVANTAGES OF COOPERATION WITH DENKIRS:

- High-quality content for website uploading
- Competitive pricing with attractive profit margins for our partners.
- Swift and dependable delivery from our warehouse in Slovenia, ensuring timely distribution.
- Dedicated personal account managers for rapid responses to all inquiries.
- Expert product assistance tailored to your needs.
- Frequent updates to our product assortment, keeping your offerings fresh and appealing.
- Strict adherence to trade policies, maintaining high standards of business practice.
- Provision of exhibition equipment and product samples for effective client presentations.
- Comprehensive support in product marketing and promotional efforts.
- Customizable terms of cooperation designed to meet your business requirements.
- Commitment to meeting deadlines, ensuring reliability and trust in our services.
- Availability of 3D models for all products to enhance project visualization and planning.





TRACK SYSTEM SMART

TRACK SYSTEM SMART



WHAT IS THE TRACK SYSTEM DENKIRS SMART?

DENKIRS SMART is a track system that enables remote lighting control from anywhere in the world and facilitates the creation of automated scenarios.

- 220V track: direct connection to the electrical network.
- Well-thought-out and functional accessories for creating various track contours.
- Includes a control panel, a converter, and a remote control.

TRACK INSTALLATION OPTIONS

1. recessed
2. surface-mounted
3. suspended

5 SERIES OF THE LIGHTS

1. GRILL
2. LINEAR
3. SPOT
4. MOON
5. RAY

FEATURES:

- 220V - no external power supply needed
- Simple system setup, eliminating the need for expert installation.
- Built-in dimming function for customizable lighting intensity.
- Adjustable color temperature ranging from 3000K to 6000K, allowing for warm to cool lighting settings.
- Versatile control options via an app, remote control, or touch panel for user convenience.
- Seamless integration with other smart devices to enable creative lighting scenarios.
- Multiple installation options to accommodate various spaces and design preferences.
- Reliable installation guaranteed by mechanical latches, ensuring secure and stable setup.
- Sturdy track construction, designed to maintain integrity over long distances without bending.



SMART GRILL

DK/EU-8001-BK



DK/EU-8002-BK



DK/EU-8006-BK

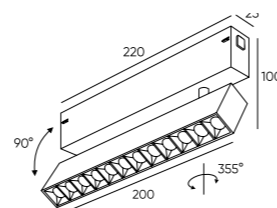
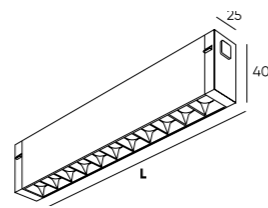
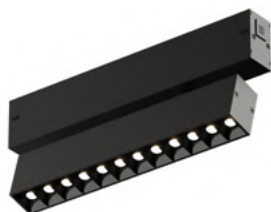

SMART LINEAR

DK/EU-8003-BK



DK/EU-8009-BK



DK/EU-8004-BK



DK/EU-8014-BK

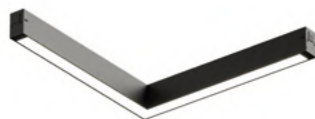

DK/EU-8005-BK

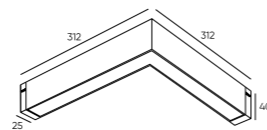
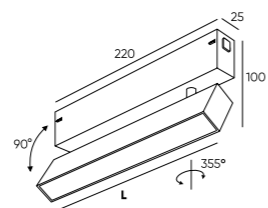
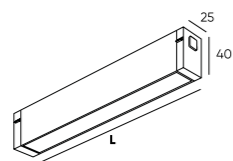

SMART SPOT

DK/EU-8010-BG



DK/EU-8010-BK



DK/EU-8008-BG



DK/EU-8008-BK



DK/EU-8020-BG



DK/EU-8020-BK

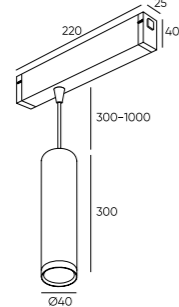
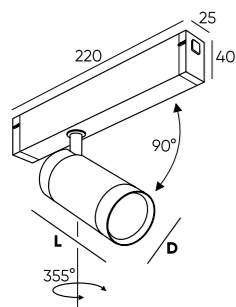

SMART MOON

DK/EU-5550-BK

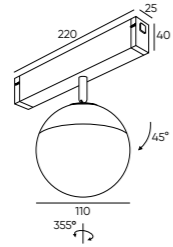

DK/EU-5552-BK

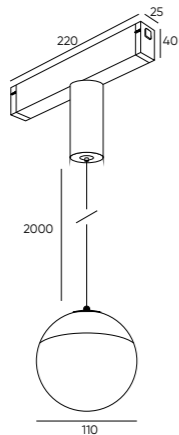

SMART RAY

DK/EU-8060-BK

DK/EU-8064-BK

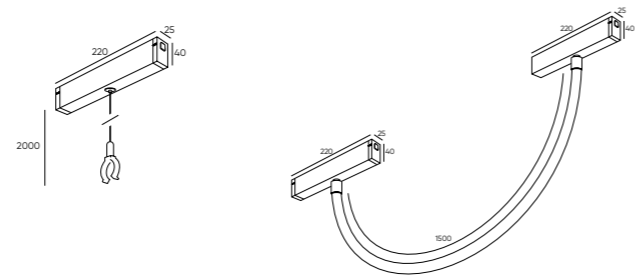
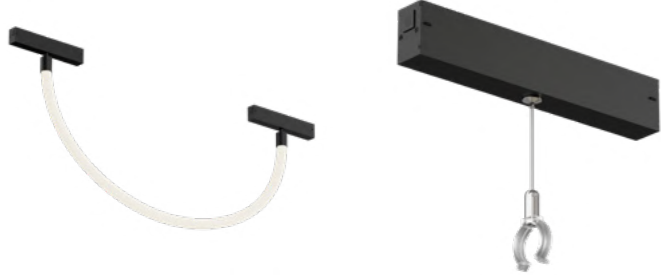

SMART CONTROL

DK/EU-7500-BK



DK/EU-7500-WH



WALL TOUCH PANEL FOR CONTROLLING THE SMART TRACK SYSTEM

This intuitive touch panel allows you to seamlessly control all lights in a track system simultaneously, as well as two separate groups of fixtures. The RF-operated, battery-powered touch panel eliminates the need for wiring, allowing for flexible installation anywhere you choose. The sleek design of the panel body not only enhances functionality, but also adds elegance to any interior.

DK/EU-7300-BK



REMOTE CONTROL FOR THE SMART TRACK SYSTEM

Allows adjust the brightness and color temperature of the lights in the track system. With the remote control, you can create up to 4 independent lighting groups and control them separately.

DK/EU-7700-WF



WI-FI CONVERTER

Enables control of the SMART track system via the Tuya Smart mobile application and voice assistant. Connects to a home Wi-Fi network at a 2.4 GHz frequency. Allows for the control of lighting through the mobile application and voice assistant from anywhere in the world. Supports up to 128 lights.

Offers the possibility to create automatic scenarios: turning lights on or off, as well as adjusting the lighting parameters based on the user's geolocation, time of day, weather, and other conditions.



SMART BASE

SMART TRACK



TR/EU-2002-BK 2 m
TR/EU-2003-BK 3 m

Includes two end caps and can be cut into sections of any desired length.

TRACK HOLDER



TR/EU-2106-BK

Specifically designed for suspended installation of the track system, this set features a cable length of 150 cm, allowing for easy adjustment to suit various installation heights. All necessary mounting hardware is included, simplifying the installation process.

POWER SUPPLY



TR/EU-2100-BK

Designed for connecting power to the track system, this component can be installed at any point along the track. It features a cable with a length of 330 mm.

STRAIGHT THROUGH CONNECTION MODULE



TR/EU-2101-BK

Engineered for connecting tracks in a straight line while facilitating the transfer of electricity between them. Includes a connector plate for seamless integration.

FLEXIBLE CONNECTION MODULE



TR/EU-2103-BK

Specifically designed to facilitate the transfer of electricity between tracks in corner connections.

TRACK RAIL PVC COVER



TR/EU-2010-BK 1 m

Designed for installation in sections of the track not occupied by lights, this component enhances the system's aesthetics. It offers the flexibility to be cut into sections of any desired length, allowing for a custom fit and a cohesive appearance.

END CAPS



TR/EU-2107-BK 2 pieces

Essential for segmenting a single track into multiple, independently installed sections.



SMART HIDE

TR/EU-2012-BK 2 м



TR/EU-2013-BK 3 м



SMART ONE

TR/EU-2022-BK 2 м

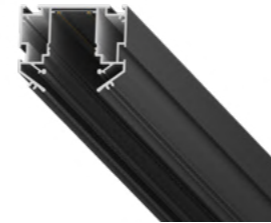

TR/EU-2023-BK 3 м

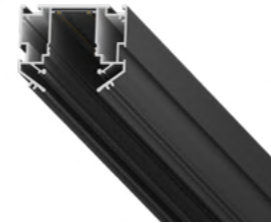

TR/EU-2026-BK



TR/EU-2025-BK

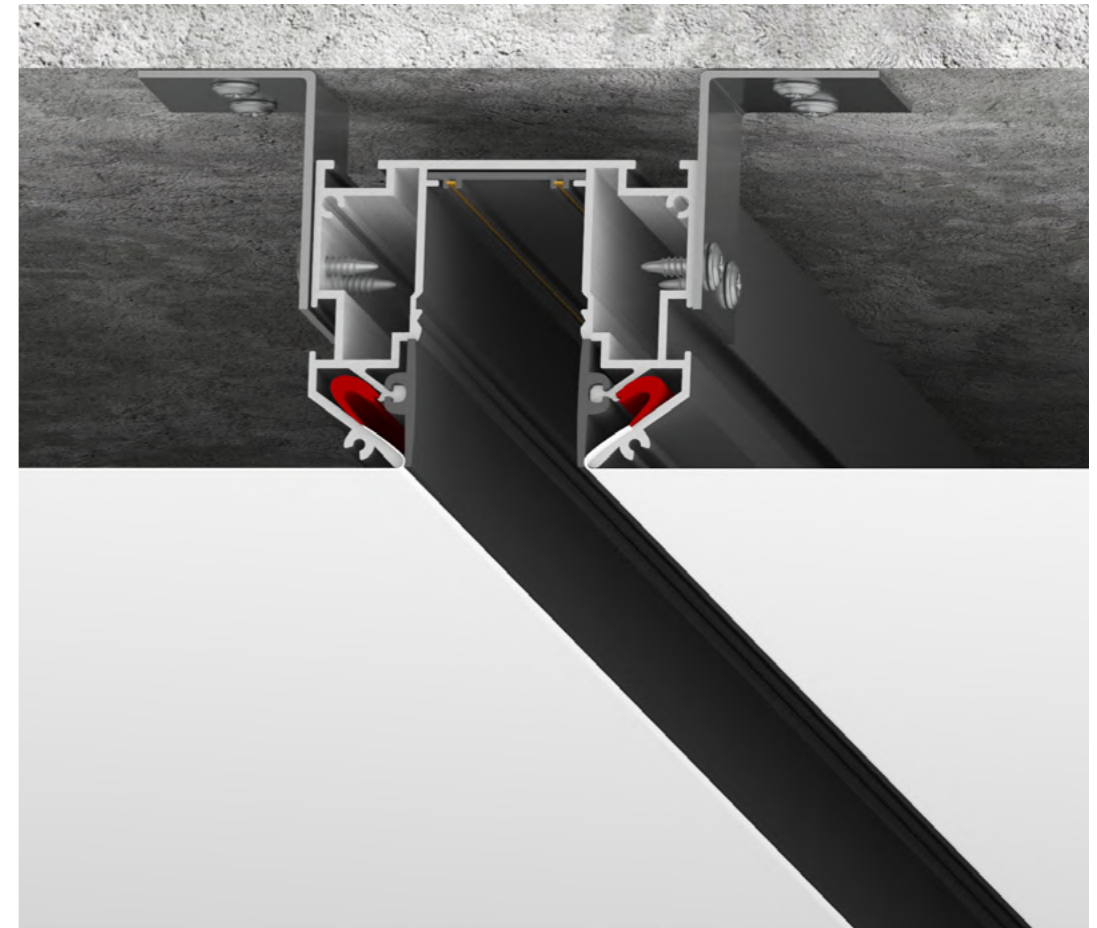
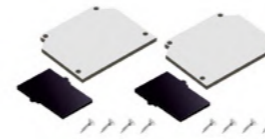

TR/EU-2026-BK



TR/EU-3043-AL



TR/EU-3045-AL





TRACK BELT
SYSTEM BELTY

TRACK BELT SYSTEM BELTY



WHAT IS THE TRACK SYSTEM BELTY?

Introducing the new generation of track systems: BELTY – where functional lighting transcends into decorative art. BELTY revolutionizes the concept with its fabric belt track embedded with copper wires, designed to power the lights seamlessly. This system boasts an extensive range of components, enabling a myriad of applications from wall-to-wall and ceiling stretches, vertical installations, to the creation of custom-made chandeliers and more. Operating on a low-voltage 48V system, BELTY ensures safety and efficiency. The system’s lights emit a color temperature of 4000K, equipped with LEDs that have a high Color Rendering Index (CRI) of over 90, guaranteeing true-to-life color reproduction

BELTY is a 28 mm wide, cotton-woven belt track, operated at 48V and available in two colors. The system includes well-thought-out and functional accessories, enabling versatile configurations in various shapes and combinations. It features five series of lights, each crafted in the minimalist design.

FEATURES:

- 48V - Maximizing Safety
- Surface mounting, ideally suited for post-renovation applications.
- A flexible belt track enables the creation of any system shape.
- Includes special mounting accessories for easy installation.

5 SERIES OF LIGHTS

1. GRILL
2. LINEAR
3. SPOT
4. ORB
5. FLOW

TRACK'S VARIATIONS

1. brown
2. dark grey

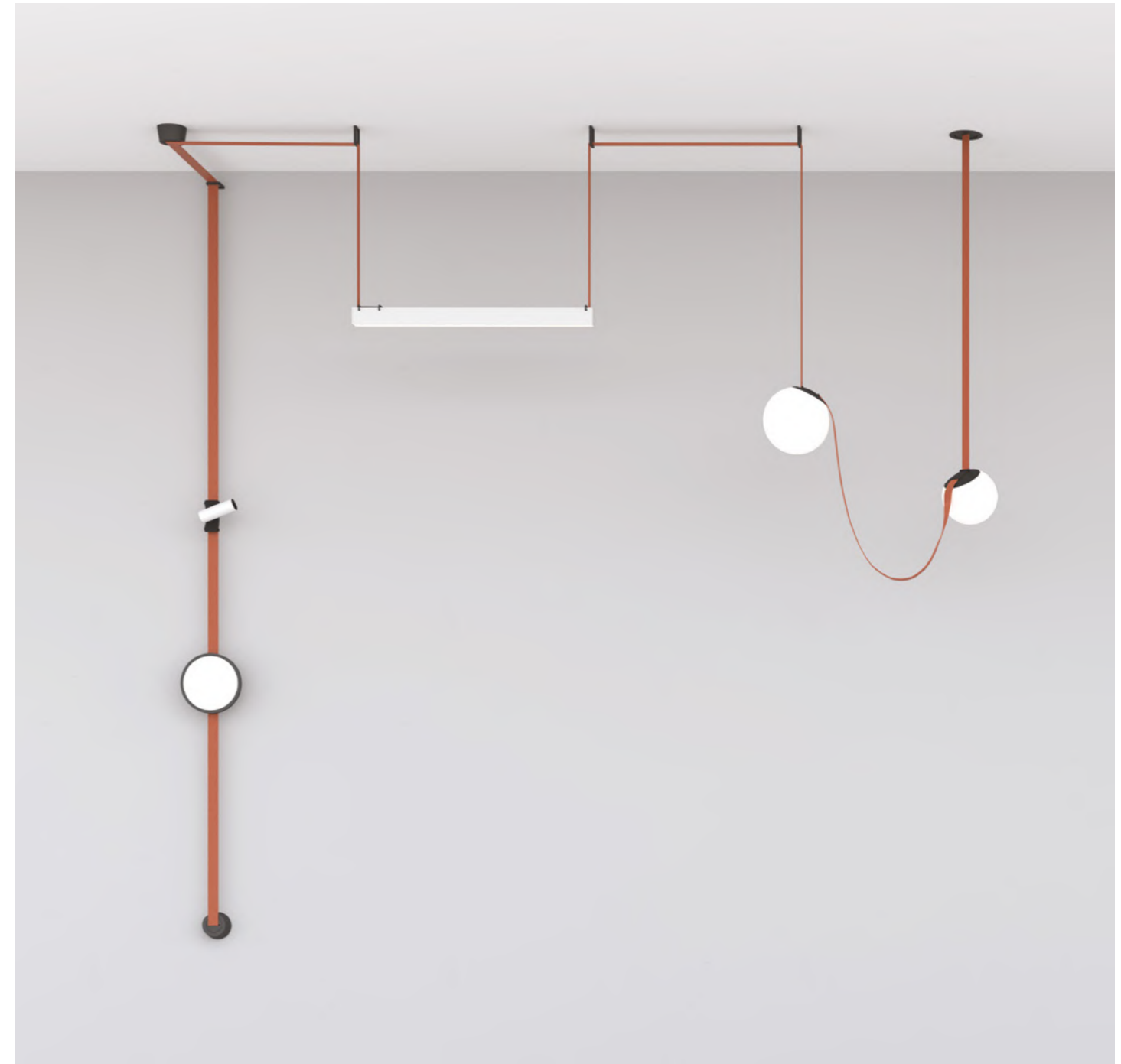

BELTY SPOT

DK/EU-5540-BK



DK/EU-5540-WH+BK



DK/EU-5542-BK



DK/EU-5542-WH+BK



DK/EU-5546-BK



DK/EU-5546-BW+BK

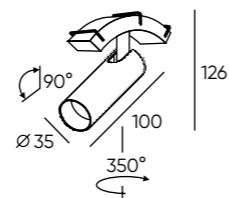
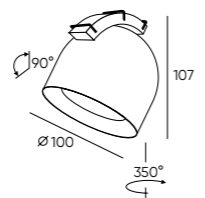

BELTY GRILL

DK/EU-5570-BK



DK/EU-5570-WB



DK/EU-5572-BK



DK/EU-5572-WB

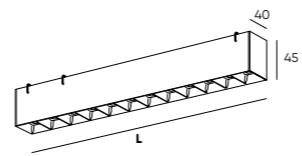

BELTY LINEAR

DK/EU-5574-BK



DK/EU-5574-WH

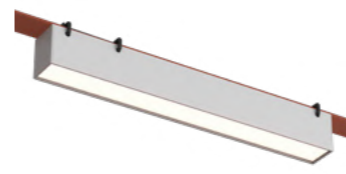

DK/EU-5576-BK



DK/EU-5576-WH

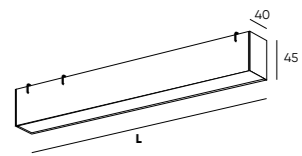

BELTY FLOW

DK/EU-5560-BK



DK/EU-5560-WH+BK



DK/EU-5564-BK



DK/EU-5564-WH+BK



DK/EU-5566-BK



DK/EU-5566-WH+BK

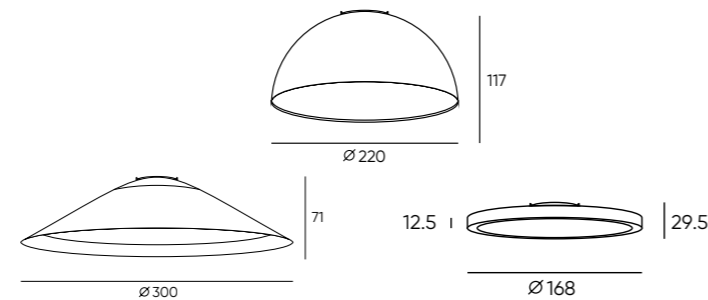

BELTY ORB

DK/EU-5550-BK



DK/EU-5552-BK

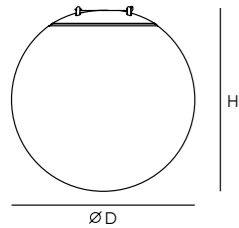

BELTY BASE

FLEXIBLE TRACK-BELT



TR/EU-5500-BR 5 m
TR/EU-5501-BR 10 m
TR/EU-5502-BR 20 m

TR/EU-5500-DG 5 m
TR/EU-5501-DG 10 m
TR/EU-5502-DG 20 m

The fabric belts, featuring woven-in copper wires, deliver power to the lights. Installation accessories are included with the set.

SURFACE-MOUNTED BASE



TR/EU-5510-BK Ø205mm
TR/EU-5511-BK Ø260mm

Designed for attaching the track-belt to a surface, some items also supply power and accommodate a step-down transformer inside.

SURFACE-MOUNTED BASE WITH A POWER SUPPLY FUNCTION



TR/EU-5512-BK Ø75mm

Designed to attach the track-belt to a surface and supply power to it.

RECESSED BASE



TR/EU-5513-BK Ø100mm

Installed in the ceiling in the manner of a recessed luminaire, this system is designed for attaching the track-belt and supplying power to the system.

SURFACE-MOUNTED BRACKET



TR/EU-5518-BK

COUNTERWEIGHT AND END CAP



TR/EU-5516-BK Ø60mm
TR/EU-5520-BK
TR/EU-5519-BK

Enables vertical installation of the track-belt, preventing any swinging of the free section. It decoratively frames the track-belt and offers the flexibility to bend it.





ULTRA-SLIM
TRACK SYSTEM AIR

ULTRA-SLIM TRACK SYSTEM AIR



WHAT IS THE TRACK SYSTEM AIR?

AIR is an 18mm wide, ultra-slim magnetic track system designed for surface mounting and operated at 48V. It is ideally suited for installations in completed renovations. Features include:

- An 18mm wide magnetic aluminum track, operated at 48V, for a sleek and modern look.
- Well-thought-out and functional accessories, enabling the creation of various track contours.
- Six series of lights, each showcasing a minimalist design.

6 SERIES OF LIGHTS

1. GRILL
2. LINEAR
3. SPOT
4. HANG
5. REFLEX
6. RAY

FEATURES:

- 48V - Maximizing Safety:
- Ideally suited for surface mounting in completed renovations, ensuring a seamless integration.
- Easy installation process designed for efficiency and convenience.
- Reliable installation guaranteed through a double fastening system: mechanical latches and magnets provide added security.



AIR GRILL

DK/EU-5305-BK



DK/EU-5335-BK



DK/EU-5308-BK



DK/EU-5338-BK

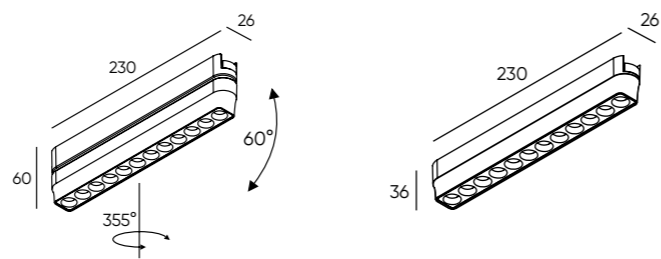

AIR LINEAR

DK/EU-5300-BK

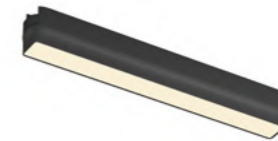

DK/EU-5303-BK

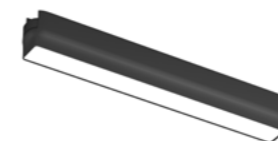

DK/EU-5330-BK



DK/EU-5333-BK

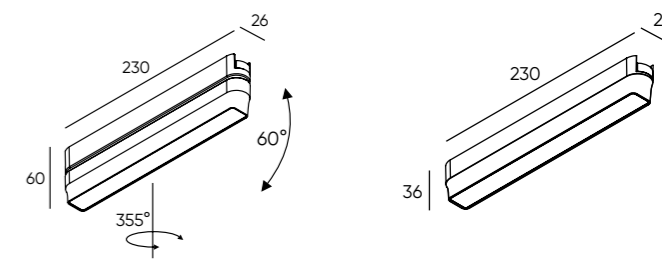

AIR SPOT

DK/EU-5310-BK



DK/EU-5340-BK



DK/EU-5311-BK



DK/EU-5341-BK



DK/EU-5313-BK



DK/EU-5343-BK

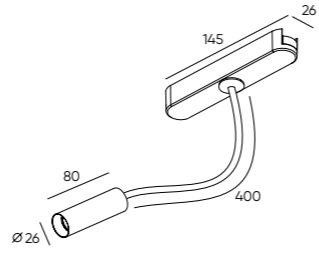
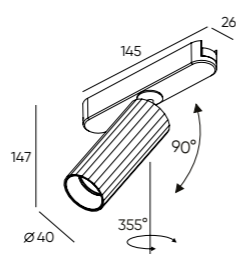

AIR REFLEX

DK/EU-5320-BK



DK/EU-5350-BK

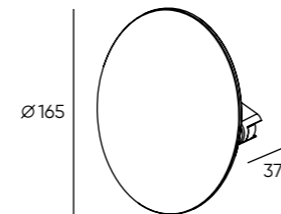

AIR HANG

DK/EU-5315-BK

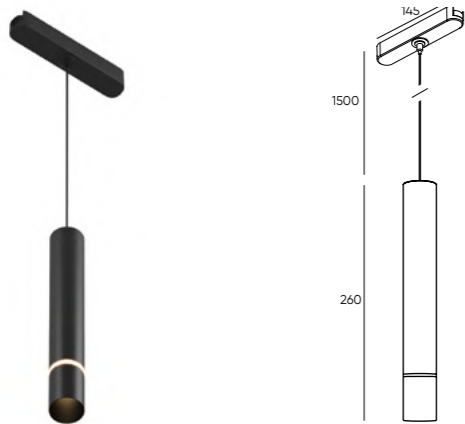

DK/EU-5345-BK



AIR RAY

DK/EU-5325-BK



DK/EU-5355-BK



DK/EU-5327-BK



DK/EU-5357-BK

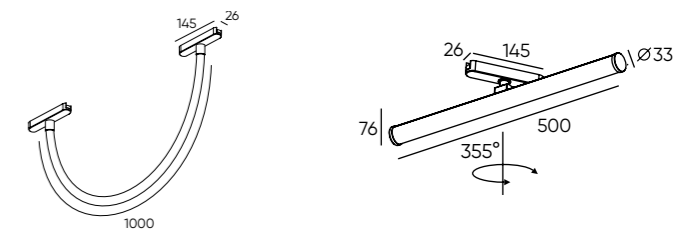

AIR BASE

ULTRA-SLIM SURFACE-MOUNTED MAGNETIC TRACK



TR/EU-5201-BK 1 m
TR/EU-5202-BK 2 m

Designed for versatile installation on both the ceiling and wall. Operates at a safe voltage of 48V. The conductive elements are ingeniously positioned at the track's ends, within a recess, rendering them completely invisible. Additionally, its design is perfectly suited for integration into finished renovations.

STRAIGHT CONNECTOR



TR/EU-5210-BK

Enables the connection of two tracks at a right angle on the ceiling, facilitating power transfer between them.

L-CONNECTOR 90°



TR/EU-5211-BK

Enables the connection of two tracks at a right angle on the ceiling, ensuring power transfer between them.

L-CONNECTOR 90°



TR/EU-5212-BK

Enables the connection of two tracks at a right angle at the wall-ceiling transition, facilitating power transfer between them.

L-CONNECTOR 90°



TR/EU-5213-BK

Incorporates a movable element that enables the connection of tracks in two planes at any angle, offering unparalleled flexibility in track layout.

DECORATIVE PLUG



TR/EU-5214-BK

Decoratively frames the track and aids in the connection of tracks. Compatible with both straight and corner connectors for versatile installation options.

POWER SUPPLY



TR/EU-5215-BK

Can be installed at any point along the track to supply power, ensuring flexible and convenient power distribution.

EXTERNAL POWER SUPPLY



TR/EU-5220-BK

Installed at a break in the track or at its end, this component converts the primary nominal voltage to 48V.

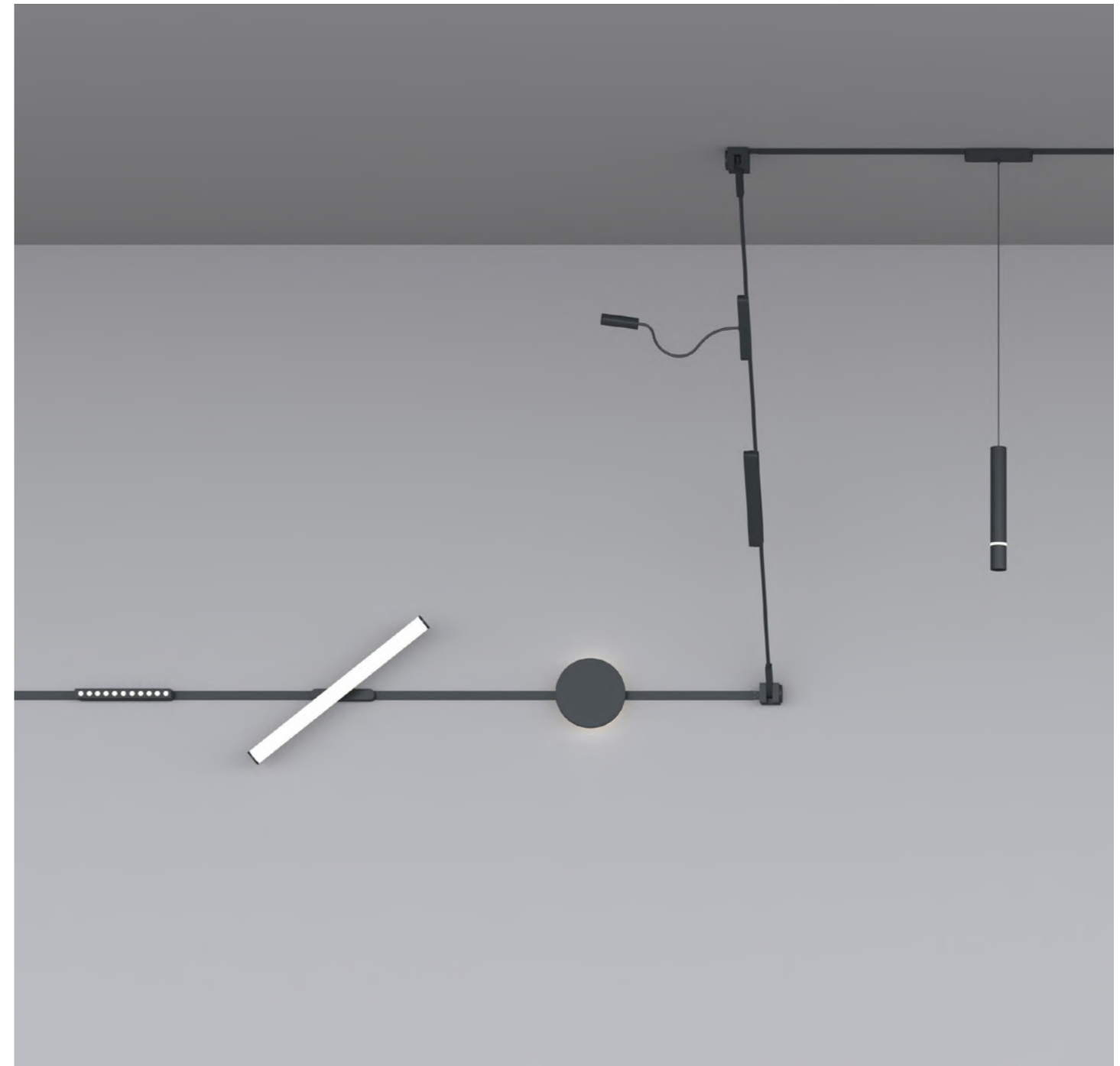

Slim LED



DENKIRS SLIM LED modules represent an evolution in LED technology, serving as the perfect light source for recessed luminaires. They maximize room height, requiring minimal space above the ceiling for maintenance and service.

ADVANTAGES:

- For accent lighting: beam angle of 60°
- CRI>80 for accurate color rendering
- Comfortable light with a flicker coefficient of less than 2%
- Includes a 3-year warranty

WHICH BULBS CAN BE REPLACED WITH SLIM LED MODULES?

DENKIRS SLIM LED modules can replace any standard bulb (halogen, fluorescent, LED) of MR16 size with a diameter of 50 mm. These bulbs are most commonly LED bulbs with a GU10 or GU5.3 base

DK/EU-3000-7W

DK/EU-4000-7W

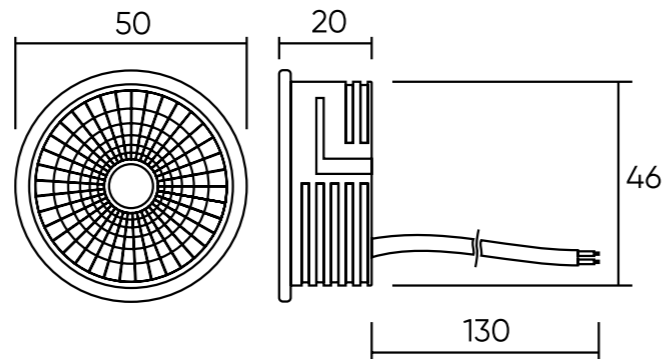

SPOTLIGHTS



SPOTLIGHTS



The DENKIRS brand offers a variety of contemporary designs in both recessed and surface-mounted spotlights.

ALL OF OUR PRODUCTS FEATURE WIDE FUNCTIONALITY, ENSURING THAT THEY MEET THE NEEDS OF ANY TURNKEY PROJECT

1. Recessed waterproof spotlights designed for humid areas.
2. The plaster-in spotlight offers a seamlessly smooth transition between the light body and the ceiling surface. Its installation technology allows the light to become invisible under a layer of plaster, creating a flawlessly integrated appearance.»
3. Classic spotlights suitable for both recessed and surface mounting

All products are made from a heat-resistant polymer commonly used in motorcycle parts manufacturing. This ensures enhanced strength and resistance to ultraviolet rays, without fading.



RODVIG

DK/EU-3061-WH



DK/EU-3061-CT



DK/EU-3061-BK

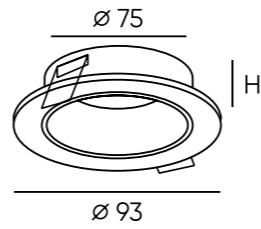

DK/EU-3071-WH



DK/EU-3071-CT



DK/EU-3071-BK

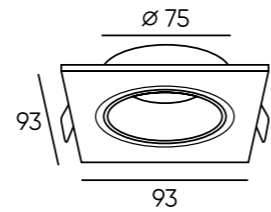
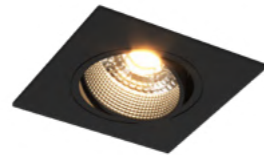

DK/EU-3072-WH



DK/EU-3072-BK

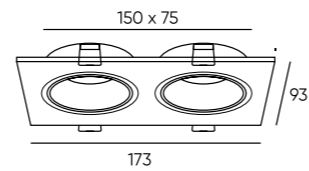

DK/EU-3090-WH



DK/EU-3090-CT



DK/EU-3090-BK

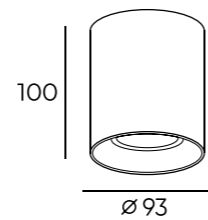

VIBI

DK/EU-3055-WH



DK/EU-3055-BK

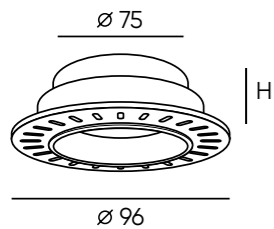

PORT

WATERPROOF SERIES

DK/EU-3101-WH



DK/EU-3101-BK

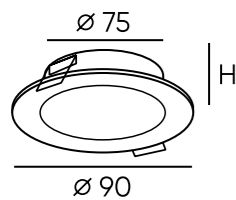

DEEP









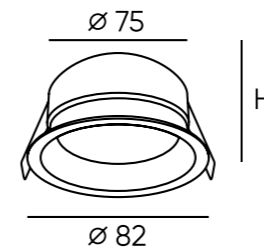





WATERPROOF SERIES















DK/EU-3103-BK



DK/EU-3103-WH



INSTALLATION FEATURES	
	Easy installation into the stretch ceilings. The recessed spotlights compatible with standard thermal rings for stretch ceilings. Installation of these spotlights does not require high qualifications and can be performed by any ceiling installer
	The diameter of the spotlight body allows for placement in the Flod decorative ceiling niche
	Designed for indoor using
	For plaster
ELECTRICAL PARAMETERS	
	Suitable for operation at 220V mains voltage. Does not require additional voltage converters
	Suitable for operation at 48V reduced voltage. Connection should be made through a power supply with corresponding characteristics
LIGHT TECHNICAL PARAMETERS	
	The CRI indicates the ability of a light source to accurately reproduce the colors of illuminated objects without distortion. The higher the value, the better the color rendition
	Enhanced CRI value. Close to the ideal indicator
	High CRI value, typical for LED light sources from known brands
	Determines the angle at which the optical part of the luminaire emits light into space. This parameter is specific to luminaires with built-in LEDs. It does not apply to lights using replaceable bulbs, as the beam angle in such models depends on the characteristics of the bulb used
	A medium beam angle is a compromise between wide and narrow angles
	A wide beam angle is typical for general flood light luminaires. Well suited for uniform illumination of a space
LIGHT SOURCE	
	Built-in LED
	Uses a replaceable LED bulb with a GU10 base, up to 15W
	Compatible with ultra-thin DENKIRS Slim LED modules

CERTIFICATION, STANDARDS, AND WARRANTY		
	Our products comply with EU safety directives	
	EU directive on the absence of harmful substances. Safe for health	
	3-year warranty on the entire DENKIRS product range	
CONTROL		
	Controlled by the Tuya smart home ecosystem	
	Controlled by the Smart Life app	
	Controlled by Home Assistant	
	Controlled by Siri	
	"Features a smooth brightness adjustment in a wide range from 1 to 100%. Controlled by SMART Control accessories. Note: Not suitable for control by standard dimmers"	
	Features a smooth color temperature adjustment in a wide range from 3000 to 6000K	
	Control via mobile app over a 2.4 GHz Wi-Fi network	
	Bluetooth control	
DUST AND MOISTURE PROTECTION RATINGS		
The first digit in the IP code indicates protection against solid objects, while the second indicates protection against moisture		
	Dust	Water
	Particles >12.5 mm	No
	Particles >1 mm	Splashes
	complete dust protection	Water jet
OTHER INDICATIONS		
	Novelty	

TRACK BELT SYSTEM BELTY

SKU	VOLTAGE	LUMINOUS FLUX	CASE COLOR	L (LENGTH)	D (DIAMETER)	ANGLE
DK/EU-5570-BK	12 W	1020 Lm	black	323 mm		
DK/EU-5572-BK	24 W	1950 Lm	black	642 mm		
DK/EU-5570-WB	12 W	1070 Lm	white/black	323 mm		
DK/EU-5572-WB	24 W	2000 Lm	white/black	642 mm		
DK/EU-5574-BK	12 W	650 Lm	black	323 mm		
DK/EU-5576-BK	24 W	1260 Lm	black	642 mm		
DK/EU-5574-WH	12 W	700 Lm	white	323 mm		
DK/EU-5576-WH	24 W	1310 Lm	white	642 mm		
DK/EU-5540-BK	12 W	1170 Lm	black			38°
DK/EU-5540-WH+BK	12 W	1250 Lm	white/black			38°
DK/EU-5542-BK	12 W	890 Lm	black			120°
DK/EU-5542-WH+BK	12 W	960 Lm	white/black			120°
DK/EU-5546-BK	7 W	380 Lm	black			30°
DK/EU-5546-BW+BK	7 W	380 Lm	white/black			30°
DK/EU-5550-BK	10 W	850 Lm	matte acrylic/black		150 mm	
DK/EU-5552-BK	10 W	850 Lm	matte acrylic/black		180 mm	
DK/EU-5560-BK	24 W	1800 Lm	black		220 mm	
DK/EU-5560-WH+BK	24 W	1870 Lm	white/black		220 mm	
DK/EU-5564-BK	12 W	1370 Lm	black		300 mm	
DK/EU-5564-WH+BK	12 W	1450 Lm	white/black		300 mm	
DK/EU-5566-BK	10 W	600 Lm	black		168 mm	
DK/EU-5566-WH+BK	10 W	600 Lm	white/black		168 mm	

TRACK LIGHTS SMART

SKU	VOLTAGE	LUMINOUS FLUX	CASE COLOR	L (LENGTH)	D (DIAMETER)	ANGLE
DK/EU-8001-BK	9 W	800 Lm	black	220 mm		
DK/EU-8002-BK	18 W	1 600 Lm	black	410 mm		
DK/EU-8006-BK	9 W	800 Lm	black	202 mm		
DK/EU-8003-BK	9 W	760 Lm	black	220 mm		
DK/EU-8004-BK	18 W	1 520 Lm	black	406 mm		
DK/EU-8005-BK	27 W	2 268 Lm	black	600 mm		
DK/EU-8014-BK	18 W	1 520 Lm	black	312*2 mm		
DK/EU-8009-BK	9 W	760 Lm	black	220 mm		
DK/EU-8010-BK	9 W	780 Lm	black	100 mm	50 mm	
DK/EU-8010-BG	9 W	780 Lm	matte gold	100 mm	50 mm	
DK/EU-8020-BK	20 W	1 800 Lm	black	130 mm	60 mm	
DK/EU-8020-BG	20 W	1 800 Lm	matte gold	130 mm	60 mm	
DK/EU-8008-BK	9 W	770 Lm	black	300 mm	40 mm	
DK/EU-8008-BG	9 W	770 Lm	matte gold	300 mm	40 mm	
DK/EU-8055-BK	12 W	960 Lm	white acrylic/black		110 mm	120°
DK/EU-8056-BK	12 W	960 Lm	white acrylic/black		110 mm	120°
DK/EU-8060-BK	18 W	1600 Лм	white acrylic	1500 mm		
DK/EU-8064-BK	-	-	clear acrylic	130 mm		

ULTRA-SLIM TRACK SYSTEM AIR

SKU	VOLTAGE	LUMINOUS FLUX	CASE COLOR	L (LENGTH)	D (DIAMETER)	COLORFUL TEMPERATURE
DK/EU-5305-BK	12 W	872 Lm	black	36 mm		3000 K
DK/EU-5308-BK	12 W	872 Lm	black	60 mm		3000 K
DK/EU-5335-BK	12 W	872 Lm	black	36 mm		4000 K
DK/EU-5338-BK	12 W	872 Lm	black	60 mm		4000 K
DK/EU-5300-BK	9 W	416 Lm	black	36 mm		3000 K
DK/EU-5303-BK	9 W	416 Lm	black	60 mm		3000 K
DK/EU-5330-BK	9 W	416 Lm	black	36 mm		4000 K
DK/EU-5333-BK	9 W	416 Lm	black	60 mm		4000 K
DK/EU-5310-BK	7 W	446 Lm	black	147 mm	40 mm	3000 K
DK/EU-5311-BK	12 W	741 Lm	black	160 mm	50 mm	3000 K
DK/EU-5313-BK	2 W	120 Lm	black	95 mm	26 mm	3000 K
DK/EU-5340-BK	7 W	446 Lm	black	147 mm	40 mm	4000 K
DK/EU-5341-BK	12 W	741 Lm	black	160 mm	50 mm	4000 K
DK/EU-5343-BK	2 W	120 Lm	black	95 mm	26 mm	4000 K
DK/EU-5315-BK	5 W	277 Lm	black		35 mm	3000 K
DK/EU-5345-BK	5 W	277 Lm	black		35 mm	4000 K
DK/EU-5320-BK	5 W	270 Lm	black			3000 K
DK/EU-5350-BK	5 W	270 Lm	black			4000 K
DK/EU-5325-BK	12 W		acrylic	500 mm		3000 K
DK/EU-5327-BK	12 W		silicone	1000 mm		3000 K
DK/EU-5355-BK	12 W		acrylic	500 mm		4000 K
DK/EU-5357-BK	12 W		silicone	1000 mm		4000 K

SLIM LED

SKU	VOLTAGE	LUMINOUS FLUX	CASE COLOR	L (LENGTH)	D (DIAMETER)	COLORFUL TEMPERATURE
DK/EU-3000-7W	7W	630 Лм	белый	20 мм	60°	3000 K
DK/EU-4000-7W	7W	630 Лм	белый	20 мм	60°	4000 K

SPOTLIGHTS

SKU	CASE COLOR	IP	installation depth with SLIM LED module	installation depth with GU5.3 lamp
DK3101-WH	white	65	35 mm	70 mm
DK3101-BK	black	65	35 mm	70 mm
DK3103-WH	white	65	50 mm	85 mm
DK3103-BK	black	65	50 mm	85 mm
DK3055-WH	white	20	45 mm	70 mm
DK3055-BK	white/black	20	45 mm	70 mm
DK3061-WH	white	20	55mm	90 mm
DK3061-CT	concrete	20	55mm	90 mm
DK3061-BK	black	20	55mm	90 mm
DK3071-WH	white	20	55mm	90 mm
DK3071-CT	concrete	20	55mm	90 mm
DK3071-BK	black	20	55mm	90 mm
DK3072-WH	white	20	55mm	90 mm
DK3090-WH	white	20		
DK3090-CT	concrete	20		
DK3090-BK	black	20		



The DENKIRS catalog is not a public offer. Typos in the catalog cannot be a reason for claims from the customer.

DENKIRS EU d.o.o. reserves the right to change product specifications without prior notice to the customer. Changes in specifications cannot be a reason for customer claims.